

*Disponible en español en [www.LennoxPros.com](http://www.LennoxPros.com).*

**Lennox<sup>®</sup> M30**  
**Smart Thermostat**  
*Installation and Setup Guide*

507739-02 3/2025  
Supersedes 2/2024  
Copyright 2024<sup>®</sup> Lennox Industries Inc.  
Dallas, Texas, USA



507739-02

## Tables of Contents

<b>Shipping and Packing List</b> .....	3	<i>Determining Wireless Connection</i>	
<b>Thermostat</b> .....	3	<i>Signal Strength</i> .....	33
<i>Unit Dimensions (H x W x D)</i> .....	3	<b>Alert Codes</b> .....	<b>34</b>
<i>Wall Plate Dimensions (H x W)</i> .....	3	<i>Service Urgent</i> .....	34
<i>Compressor Short-Cycle Protection</i>		<i>Service Soon</i> .....	34
<i>(Compressor Protect)</i> .....	3	<i>Service Soon / Service Urgent</i> .....	34
<b>Installation Considerations</b> .....	<b>4</b>	<i>Maintenance</i> .....	34
<b>Outdoor Air Temperature Sensor Installation</b>		<i>Dealer Information only</i> .....	34
<b>(Optional)</b> .....	<b>4</b>	<b>System Test Modes</b> .....	<b>40</b>
<b>Thermostat Installation</b> .....	<b>5</b>	<b>Save Energy Default</b> .....	<b>41</b>
<i>New Installation</i> .....	5	<b>Dehumidification Control</b> .....	<b>41</b>
<i>Replacement Installation</i> .....	6	<i>Normal and Max</i> .....	41
<i>Common Installation Practices</i> .....	6	<i>Humiditrol</i> .....	42
<i>Thermostat Terminal Information</i> .....	7	<i>Auxiliary Dehumidifier</i> .....	42
<i>System Wiring Diagrams</i> .....	8	<b>Humidification Control</b> .....	<b>43</b>
<i>Connecting Thermostat Wiring</i> .....	8	<i>Normal and Max</i> .....	43
<i>Supported Configurations</i> .....	8	<i>Normal and Max Dew Point Control</i> .....	44
<i>Install Thermostat to Backplate</i> .....	11	<b>Ventilation Control</b> .....	<b>45</b>
<b>Commissioning and Advanced Settings</b> .....	<b>11</b>	<i>Ventilation Rates</i> .....	45
<i>Commissioning</i> .....	12	<i>Energy Recovery Ventilator (ERV)</i> .....	45
<i>Advanced Settings</i> .....	14	<i>Heat Recovery Ventilator (HRV)</i> .....	45
<i>Advanced Settings Parameter Descriptions</i> .....	22	<i>Fresh Air Damper</i> .....	45
<b>Stage Control</b> .....	<b>26</b>	<i>Ventilation Wiring</i> .....	46
<b>Wi-Fi Connection</b> .....	<b>30</b>	<i>Ventilation Control Modes</i> .....	47
<i>Connecting to Visible Home Wi-Fi Access Point</i> ...	31	<b>Installer Checklist</b> .....	<b>47</b>
<i>Connecting to Hidden Home Wi-Fi Access Point</i> ..	32		
<i>Wireless Terminology</i> .....	32		
<b>Wireless Connectivity Troubleshooting Tips</b> ...	<b>32</b>		

## Shipping and Packing List

Item	Quantity
M30 Thermostat with backplate attached	1
Wall plate	1
Mounting screws (M3.5x25mm self-tapping screws)	2
Wall anchors	2
Warranty sheet	1
Installation & setup guide	1
User guide	1
System Wiring Diagrams Fold-Out Sheet	1

## Thermostat

### Unit Dimensions (H x W x D)

Dimensions: 3-5/16 x 4-5/16 x 7/8 in.  
(84 x 110 x 22mm)

### Wall Plate Dimensions (H x W)

Dimensions: 4-1/2" x 5-3/4" (114 x 146mm)

### Compressor Short-Cycle Protection (Compressor Protect)

This thermostat is equipped with automatic compressor protection to prevent potential damage due to short cycling or extended power outages.

The non-adjustable short-cycle protection provides a 5-minute delay between heating or cooling cycles to prevent the compressor from being damaged.

**NOTE:** *There is an option in advanced settings that will allow this safety feature to be disabled. By default it is set to ON. Short Cycle protection is disabled during testing of the outdoor unit. It is automatically reset once the test is completed.*

## WARNING

Improper installation, adjustment, alteration, service or maintenance can cause property damage, personal injury or loss of life.

Installation and service must be performed by a licensed professional HVAC installer (or equivalent) or a service agency.

## WARNING

Always turn off power at the main power source by switching the circuit breaker to the OFF position before installing or removing this thermostat.

All wiring must conform to local and national building and electrical codes and ordinances.

## **IMPORTANT**

In all applications, the M30 thermostat can only be used with all residential units and approved commercial split-system matches, and those which meet the following installation criteria:

Installation uses 18 gauge thermostat wire or larger and wire run length **DOES NOT EXCEED** 300 feet (91 meters).

Load from any thermostat connection is 1 AMP or less.

When using the outdoor sensor and connecting to the To and Tc outdoor temperature terminal connections we suggest using a separate 2-wire thermostat wire cable to the sensor.

## **CAUTION**

This is a 24VAC low-voltage thermostat. Do not install on voltages higher than 30VAC.

Do not short (jumper) across terminals on the gas valve or at the system control to test installation.

This will damage the thermostat and void the warranty.

### **Installation Considerations**

Before beginning installation, note the type of equipment, number of stages, and any accessories being installed. This thermostat is a 24VAC low-voltage thermostat and requires a common wire to the thermostat to operate.

- Shut off all power to system components before installing thermostat.
- Make sure that all wiring conforms to local and national building and electrical codes and ordinances.
- Never short (jumper) across terminals on the gas valve or at the system control to test installation. This will damage the thermostat and void the warranty.
- Never install thermostat on outside walls or in direct sunlight.

### **Outdoor Air Temperature Sensor Installation (Optional)**

The optional outdoor air (temperature) sensor (OATS) (X2658) wiring distance to M30 should not exceed 150 feet (45 meters) when wired with minimum 22 #AWG (recommend 18 #AWG) dedicated 2-conductor thermostat cable. Installation of OATS must comply with the following requirements:

The sensor is required for:

- Outdoor temperature displays on the home screen if enabled
- Balance point adjustment and control. The sensor enables optimal heating equipment operation via programmable balance points.
- Dew point humidity control
- Humiditrol EDA operation (required)
- Connects to **To** and **Tc** terminals on thermostat

**NOTE:** *If alert code 108 appears on the screen, check your wiring connections to terminals **To** and **Tc** on the thermostat. Check resistances using the resistance table provided in the outdoor sensor instruction.*

## Thermostat Installation

### New Installation

---

The following procedure is for new installation or installing the M30 to a new location in an existing home.

1. Unpacked the thermostat and open the case with a thin-blade screwdriver. Place between wall base and unit and twist to separate unit from base.
2. Select a location for the thermostat about 5 feet (1.5 meters) above the floor in an area with good air circulation at average temperature.

3. Do not install the thermostat where it can be affected by:
  - Drafts or dead spots behind doors and in corners.
  - Building entrances or automatic doors
  - Heat generating equipment such as kitchen equipment
  - Hot or cold air from ducts.
  - Radiant heat from sun or appliances.
  - Concealed pipes and chimneys.
  - Non-heated (non-cooled) areas such as an outside wall behind the thermostat.
4. Run thermostat wiring from indoor unit to location where thermostat will be installed.
5. Drill or make opening through wall for thermostat wiring 3/4" x 3/4" (19mm x 19mm).
6. Pull about three inches (76mm) of thermostat wire through the opening and removed outer thermostat wire jacket. This will help in routing the thermostat wiring to the proper thermostat terminals.

**NOTE:** *Thermostat wires and outdoor sensor wire can be run in the same bundle of wires if needed.*

7. Seal the hole in the wall with a suitable material to prevent drafts from entering the thermostat case. Not doing so could affect the thermostat's internal temperature sensor.
8. Trim 1/4 inch (6 mm) insulation from end of each thermostat wire lead.

## Replacement Installation

Use the following two steps to replace an existing thermostat:

1. Remove existing thermostat.
2. Note the wire colors and what terminals they are connected for future reference.

## Common Installation Practices

Use the provided wall plate as a template on where to drill the mounting holes.

**NOTE:** Installation of wall plate is optional. Use a field-provided level to allow for proper alignment.

3. Drill 3/16" (5 mm) holes in wall for provided wall anchors. Insert provided wall anchors into drilled holes.
4. Remove back plate from main thermostat assembly using a flat-head screw driver.

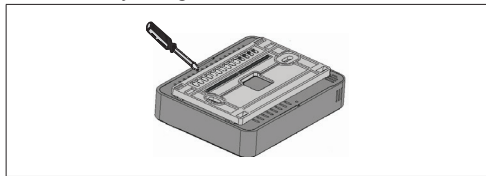

5. Route thermostat and outdoor temperature sensor (optional) wiring from wall through center openings on wall plate (use is optional) and back plate.

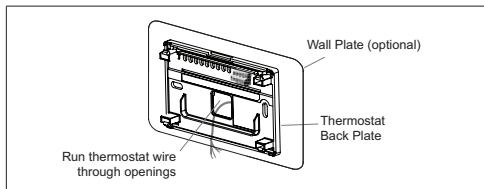

6. Secure back plate and wall plate (optional) to wall with the two provided mounting screws.

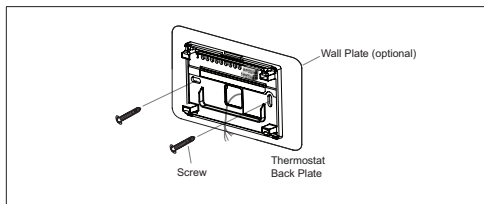

## Thermostat Terminal Information

**Table 1. Terminal Designations**

Terminal	Purpose
Tc and To	Used for connection to an optional outdoor temperature sensor. Use only dedicated 2-conductor thermostat wire.
ACC1 and ACC2	Default factory software setting for ACC (Accessory) is off.  Terminal function setting can be changed by going to <b>settings &gt; advanced settings &gt; terminal settings</b> . Available settings are off, humidify and dehumidify. Connect accessory to terminal ACC2 and change software setting to the applicable type of accessory. Power is supplied by R2 to ACC1 factory jumper.  <b>NOTE:</b> <i>The ACC1 is intended to be the voltage input terminal for the ACC relay. If the ACC relay is configured as a Dehumidifier and Humidifier, the ACC1 terminal needs to be jumpered to "R2" to supply the 24VAC from the HVAC system's 24V source. A jumper between R2 and ACC1 will be shipped installed by the factory.</i>
	<b>NOTE:</b> <i>If the ACC terminal is used for ventilator devices which have their own voltage supply and need a set of "dry relay contacts" then the jumper will need to be removed from R2-ACC1.</i>
R2	This is the secondary 24VAC power source for ACC (Accessory). The R2 terminal is connected to the ACC1 terminal by factory provided jumper.

**Table 1. Terminal Designations**

Terminal	Purpose
D/H	This terminal is for an optional dehumidifier or humidifier.  The D/H terminal is powered using the HVAC system's 24VAC source ("R").  Factory default software setting is for humidify. Terminal settings can be changed by going to <b>settings &gt; advanced settings &gt; terminal settings</b> . Available settings are off, humidify and dehumidify.  <b>NOTE:</b> <i>The user interface refers to the terminal as D/H.</i>
W2	Second-stage heating (non-heat pump) or 4th stage (heat pump).
Y2	Second-stage heating or cooling.
O/B	Heat pump reversing valve operations. When O (default) is selected under <b>settings &gt; advanced settings &gt; terminal settings</b> , the relay is ON during cooling and OFF during heating.  When B is selected, the relay is ON during heating and OFF during cooling.
C	Common 24VAC
G	Fan relay
W1	First-stage heating (non-heat pump or emergency heat) or third-stage heating (heat pump)
Y1	First-stage heating or cooling
R	24VAC power

**Table 2. O/B Terminal Relationship States**

State	O/B Terminal Control
<b>Power ON</b>	O terminal : ON (If O terminal selected) B terminal : OFF (If B terminal selected)
<b>Heat only or emergency heat mode</b>	O terminal : always OFF B terminal : always ON
<b>Cool mode only</b>	O terminal : always ON B terminal : always OFF
<b>Heat/Cool mode</b>	During heating O terminal : OFF B terminal : ON During cooling O terminal : ON B terminal : OFF No Demand The terminal continues the previous ON / OFF state
<b>Off mode</b>	The terminal state continues the state before entering off mode

## System Wiring Diagrams

For system diagrams, see the included fold-out Lennox M30 Smart Thermostat System Diagrams sheet.

## Connecting Thermostat Wiring

Use “Table 1. Terminal Designations” on page 7 for connecting the thermostat wiring to the back plate terminals.

If this is a replacement thermostat, connect to terminals as noted when removing the old thermostat. If terminals were different on old thermostat, use “Table 1. Terminal Designations” on page 7 and wiring diagrams provided in the kit.

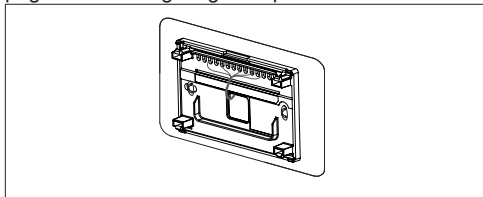

**NOTE:** Remember to seal the hole in the wall with a suitable material to prevent drafts from entering the thermostat case. Not doing so could affect the thermostat's internal temperature sensor.

## Supported Configurations

See “Table 3. Supported Configurations” on page 9.



**Table 3. Supported Configurations**

Outdoor unit setting	Indoor unit setting	Comp. Stages	Indoor Heat Stages	Heat Stages	Cool Stages	Heat Stage				EM Heat Stage		Cool Stage	
						1st	2nd	3rd	4th	1st	2nd	1st	2nd
HP	No Heat	1	0	1	1	Y1	-	-	-	-	-	Y1	-
		2	0	2	2	Y1	Y1+Y2	-	-	-	-	Y1	Y1+Y2
	Gas / Oil	1	1	2	1	Y1	W1	-	-	W1	-	Y1	-
		1	2	3	1	Y1	W1	W1+W2	-	W1	W1+W2	Y1	-
		2	1	3	2	Y1	Y1+Y2	W1	-	W1	-	Y1	Y1+Y2
		2	2	4	2	Y1	Y1+Y2	W1	W1+W2	W1	W1+W2	Y1	Y1+Y2
	Elec	1	1	2	1	Y1	Y1+W1	-	-	W1	-	Y1	-
		1	2	3	1	Y1	Y1+W1	Y1+W1+W2	-	W1	W1+W2	Y1	-
		2	1	3	2	Y1	Y1+Y2	Y1+Y2+W1	-	W1	-	Y1	Y1+Y2
		2	2	4	2	Y1	Y1+Y2	Y1+Y2+W1	Y1+Y2+W1+W2	W1	W1+W2	Y1	Y1+Y2

**Table 3. Supported Configurations**

Outdoor unit setting	Indoor unit setting	Comp. Stages	Indoor Heat Stages	Heat Stages	Cool Stages	Heat Stage				EM Heat Stage		Cool Stage	
						1st	2nd	3rd	4th	1st	2nd	1st	2nd
A/C	No Heat	1	0	-	1	-	-	-	-	-	-	Y1	-
		2	0	-	2	-	-	-	-	-	-	Y1	Y1+Y2
	Gas / Oil or Elect	1	1	1	1	W1	-	-	-	-	-	Y1	-
		1	2	2	1	W1	W1+W2	-	-	-	-	Y1	-
		2	1	1	2	W1	-	-	-	-	-	Y1	Y1+Y2
		2	2	2	2	W1	W1+W2	-	-	-	-	Y1	Y1+Y2
No OU	Gas / Oil or Elect	0	1	1	0	W1	-	-	-	-	-	-	-
		0	2	2	0	W1	W1+W2	-	-	-	-	-	-

OU = Outdoor Unit  
Elect = Electrical Heat

## Install Thermostat to Backplate

The thermostat assembly simply snaps onto the back plate. Once secure to the back plate apply power to the system. Thermostat should boot up and go into the commissioning process.

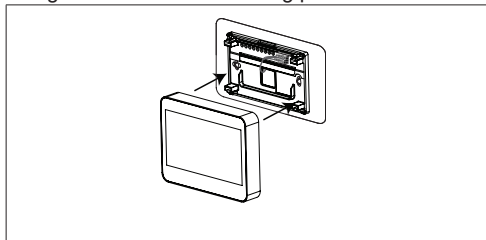

**Figure 1. Installing Thermostat**

If power is applied and the thermostat screen remains off, inspect and verify all wire connections.

## Commissioning and Advanced Settings

After power is applied to the thermostat for the first time it displays the Lennox® “splash screen”.

The Installer is then presented with the several Setup Screens to configure the system prior to operation.



## Commissioning

“Table 4. Commissioning Screens” on page 12 list all of the screens and parameters that can be configured during the commissioning phase.

**Table 4. Commissioning Screens**

MENU		SETTING (default is bold)		Notes:	
DEALER INFO	Dealer ID Number	Enter id		Installer can add the dealer number and phone number using the keyboard tool.	
	Dealer Phone Number	Enter phone			
	Name, email, website, dealer address (address1, address2, city, state and zip/postal code)				
GENERAL	Language	<b>English</b>			
		Français			
		Español			
	Country/Region	<b>United States</b>			
		Canada			
		Australia			
	Date and Time	Time		Adjust the date and time using the set date and set time tools.	
		Date			
		Time Zone\	Atlantic		
			Eastern		
Central					
Mountain					
Pacific					

**Table 4. Commissioning Screens**

MENU		SETTING (default is bold)		Notes:
GENERAL	Date and Time	Time Zone\	Alaska	
			Hawaii	
			Samoa	
			Chamorro (Guam)	
		Daylight Savings	On or Off	
		Temperature Units	°F or °C	
<b>TERMINAL SETTINGS</b>		(See Terminal Settings on page 21)		
<b>SYSTEM SETUP</b>		(See System Setup on page 14)		
<b>OUTDOOR SENSOR</b>		(See Outdoor Sensor on page 16)		
HUMIDITY	Humidity Control	<b>Off</b>		
		Humidify		
		Dehumidify		
	Dehumidification Control Center	Normal or Max		Displayed if Dehumidify is selected
	Overcooling	2F		Display if Max is enabled
Dehumidification Set-Point	50%		Displayed if Dehumidify is selected adjustable (40 to 60%)	

**Table 4. Commissioning Screens**

MENU		SETTING (default is bold)	Notes:
NOTIFICATIONS (Reminders)	Replace Filter 1	Disabled	Adjustable 3, 6, 12, 24 months or custom date, can be set to calendar time or run-time.  Touch custom to access the Set date Tool screen to input custom date settings.
	Replace Filter 2	Disabled	
	Replace UV Bulb	Disabled	
	Replace Humidifier Pad	Disabled	
	PureAir Maintenance	Disabled	
	Maintenance Reminder	Disabled	

### Advanced Settings

“Table 5. Advanced Settings” on page 14 list the menu options and parameters that can be set under the Advance Settings menu option.

**Table 5. Advanced Settings**

MENU		SETTING (default is bold)	Notes:
SYSTEM SETUP	Ventilator Type	<b>None</b>	
		Fresh Air Damper	
		HRV	
		ERV	

**Table 5. Advanced Settings**

MENU		SETTING (default is bold)	Notes:
<b>SYSTEM SETUP</b>	<b>Outdoor Unit Type</b>	<b>Not Installed</b>	
		1 Stage A/C Unit	
		2 Stage A/C Unit	
		1 Stage HP Unit	
		2 Stage HP Unit	
		Outdoor Unit Capacity - 36 kBtu	Adjustable 18 to 60 kBu
		Outdoor Unit 1st Stage Capac (capacity)	Adjustable 30 to 100%. Default is 70%. (This setting is only available if outdoor unit is 2-stage.)
	<b>Indoor Unit Type</b>	<b>Not Installed</b>	
		1 Stage Electric	
		2 Stage Electric	
		1 Stage Oil	
		2 Stage Oil	
		1 Stage Gas	
		2 Stage Gas	

**Table 5. Advanced Settings**

MENU		SETTING (default is bold)	Notes:
SYSTEM SETUP	Humidifier	<b>Not Installed</b>	These options only appear under System Setup if the D/H and ACC terminals have been enabled for the specific type of accessory. Go to Terminal Settings to enable attached accessory for the specific terminal being used.
		Humidification	
	Dehumidifier	<b>Not Installed</b>	
		Humiditrol - Min	
		Humiditrol - Mid	
		Humiditrol - Max	
		Auxiliary Dehumidifier	
The Humiditrol settings provides adjustment of Humiditrol overcooling operation. Overcooling from two degrees below the cooling set point down to two degrees above the heating set point is provided. The minimum overcooling of two degrees below the cooling set point is represented by "MIN". The maximum overcooling of two degrees above the heating set point or 65°F is represented by "MAX". Halfway between is represented by "MID". The default is "MAX".			
OUTDOOR SENSOR		Yes or <b>No</b>	Required for high and low balance points options.
RESIDUAL COOL		<b>0, 30, 60, 90, 120 seconds, -300 (5 minute delayed)</b>	
BALANCE POINT	<p><b>Disabled</b> or Enabled</p> <p>Setting used to prevent the heat pump from heating the structure. The outdoor temperature is below the level where the heat pump is programmed to heat the home).</p> <p><b>NOTE:</b> <i>Balance point option will not appear on the menu until system is configured correctly and a outdoor temperature sensor is installed and enabled in the thermostat.</i></p>	<p>When enabled:</p> <p>Low Balance Point: 25°F (-20 to 72°F) Adjustments are in increments of 1°F (0.56°C).</p> <p>Setting used to prevent the heat pump from heating the structure. (Alert 18 - Minor - Notification only - The outdoor temperature is below the level where the heat pump is programmed to heat the home).</p>	



**Table 5. Advanced Settings**

MENU	SETTING (default is bold)	Notes:
		<p>High Balance Point: 50°F (-17 to 75°F). Adjustments are in increments of 1°F (0.56°C).</p> <p>This setting is used to prevent the furnace or electric heat from heating the structure. (Alert 19 - Minor - Notification only - The outdoor temperature is higher than the level where the furnace or electric heat is programmed to heat the home.)</p>
TEMPERATURE CONTROL MODE	Normal and <b>Comfort</b>	<p>The Feels-Like feature factors in the outdoor temperature and indoor humidity for a more accurate control of the temperature in the home. Either an outdoor temperature sensor is used or Internet Weather is enabled for this feature to operate. Modifying this setting here will also change the feature status on the user settings screen.</p> <ul style="list-style-type: none"> <li>• Normal - This setting cools or heats the home to the desired temperature setting (Feels Like is OFF).</li> <li>• Comfort - This setting cools or heats the home to the desired temperature setting (Feels Like) is ON. When set to ON, other parameters are modified to optimal settings for this feature. Those setting changes will be listed on-screen when Comfort is enabled.</li> </ul> <p>Default is Comfort.</p>
WALL INSULATION	Poor, <b>Average</b> and Good	<p>Poor, Average and Good represents the insulation form factor value considered for temperature anticipation value</p>
DEADBAND	Adjustable (3 to 8 degrees)	<p>Prevents the Heating and Cooling from being set closer together than 3 degrees or greater than 8 degrees (Dead- band).</p> <p>Default is 3°F.</p>

**Table 5. Advanced Settings**

MENU	SETTING (default is bold)	Notes:
SMOOTH SETBACK RECOVERY	<b>Enabled</b> or Disabled	When enabled, smooth set back begins recovery up to two hours before the programmed time so that the programmed temperature is reached at the corresponding programmed event time. Assume 12°F (6.72°C) per hour for first-stage gas/electric heating and 6°F (3.36°C) per hour for first-stage compressor based heating or cooling. With Smooth Set Back disabled, the system will start a recovery at the programmed time. Options are enabled or disabled. Default is enabled.
OFFSET	Temperature Offset - 0°F	Adjustable (-5 to 5°F)
	Humidity Offset - 0%	Adjustable (-10 to 10%)
STAGE DIFFERENTIAL	Stage 1 - 1.0°F	Adjustable (0.5 to 8.0°F)
	Stage 2 - 1.0°F	Adjustable (0.5 to 8.0°F)
	Stage 3 - 0.5°F	Adjustable (0.5 to 8.0°F)
	Stage 4 - 0.5°F	Adjustable (0.5 to 8.0°F)
STAGE DELAY	On or <b>Off</b>	
	Stage 2 through 4 - 20 min.	Adjustable (5 to 120 minutes). Default is 20 min.
H/C STAGES LOCKED IN	Enable or <b>Disable</b>	Turns heating stages off separately

**Table 5. Advanced Settings**

MENU	SETTING (default is bold)	Notes:
<b>VENTILATION SETTINGS</b>	<b>Ventilator Type: ERV or HRV</b>	
	<b>VENTILATION CONTROL MODE (VCM): ASHRAE or Timed</b>	
<b>NOTE:</b> <i>Thermostat ventilation rate parameter are to be adjusted only after the HRV/ERV set up is completed and the CFMs are known. Once the thermostat's CFMs are adjusted they are used with the thermostat's timer algorithm to determine how long to run the HRV/ERV.</i>		
<b>VCM = TIMED</b>	Ventilation Minutes Per Hour	Default is 20 minutes. Range is 0 to 60 minutes
	Ventilation Rate	Default is 130 CFM. Range is 20 to 500 CFM
	Ventilation High Outdoor Temperature Limit	Default is 100°F. Range is 60°F to 115°F.
	Ventilation Low Outdoor Temperature Limit	Default is 0°F. Range is -20°F to 55°F.
	Ventilation High Outdoor Dew Point Limit	Default is 55°F. Range is 45°F to 80°F.
<b>VCM = ASHRAE and Ventilation Outdoor Condition Override is set to ENABLED.</b>  <b>NOTE:</b> <i>In this mode the thermostat can assist the installer by validating the ventilation CFMs are capable of meeting the ASHRAE required ventilation volumes, but the thermostat has no ability to control CFM from the HRV/ERV.</i>	Ventilation Rate	Default is 500 CFM. Range is 20 to 500 CFM.
	Ventilation High Outdoor Temperature Limit	Default is 100°F. Range is 60°F to 115°F.
	Ventilation Low Outdoor Temperature Limit	Default is 0°F. Range is -20°F to 55°F.
	Ventilation High Outdoor Dew Point Limit	Default is 55°F. Range is 45°F to 80°F.
	ASHRAE Compliance Check	YES or No: Current settings comply with ASHRAE 62.2.
	ASHRAE Infiltration Credit	Default is 0 CFM. Range is 0 to 200 CFM.
	ASHRAE house floor area serviced by this ventilator	Default is 2500 square feet. Range is 500 to 5000 square feet.
	ASHRAE Number of Bedrooms	Default is 3. Range is 1 to 10.

**Table 5. Advanced Settings**

<b>MENU</b>	<b>SETTING (default is bold)</b>	<b>Notes:</b>
<b>VENTILATION SETTINGS</b>	<b>Ventilator Type: Fresh Air Damper</b>	
	<b>VENTILATION CONTROL MODE (VCM): ASHRAE or Timed</b>	
<b>VCM = TIMED</b>	Relay Setting to Work Fresh Air Damper	Closed or Open. Default is Closed.
	Ventilation Minutes Per Hour	Default is 20 minutes. Range is 0 to 60 minutes
	Ventilation High Outdoor Temperature Limit	Default is 100°F. Range is 60°F to 115°F.
	Ventilation Low Outdoor Temperature Limit	Default is 0°F. Range is -20°F to 55°F.
	Ventilation High Outdoor Dew Point Limit	Default is 55°F. Range is 45°F to 80°F.
<b>VCM = ASHRAE and Ventilation Outdoor Condition Override is set to DISABLED.</b>	Relay Setting to Work Fresh Air Damper	Closed or Open. Default is Closed.
	ASHRAE Compliance Check	YES or No: Current settings comply with ASHRAE 62.2.
	ASHRAE Infiltration Credit	Default is 0 CFM. Range is 0 to 200 CFM.
	ASHRAE house floor area serviced by this ventilator	Default is 2500 square feet. Range is 500 to 5000 square feet.
	ASHRAE Number of Bedrooms	Default is 3. Range is 1 to 10.
	Fresh Air Damper Ventilation CFM	Default is 75 CFM. Range is 20 to 250 CFM.
<b>VCM = ASHRAE and Ventilation Outdoor Condition Override is set to ENABLED.</b>	Ventilation High Outdoor Temperature Limit	Default is 100°F. Range is 60°F to 115°F.
	Ventilation Low Outdoor Temperature Limit	Default is 0°F. Range is -20°F to 55°F.
	Ventilation High Outdoor Dew Point Limit	Default is 55°F. Range is 45°F to 80°F.
	ASHRAE Compliance Check	YES or No: Current settings comply with ASHRAE 62.2.
	ASHRAE Infiltration Credit	Default is 0 CFM. Range is 0 to 200 CFM.
	ASHRAE house floor area serviced by this ventilator	Default is 2500 square feet. Range is 500 to 5000 square feet.
	ASHRAE Number of Bedrooms	Default is 3. Range is 1 to 10.

**Table 5. Advanced Settings**

MENU		SETTING (default is bold)	Notes:
VCM = ASHRAE and Ventilation Outdoor Condition Override is set to ENABLED		Fresh Air Damper Ventilation CFM	Default is 75 CFM. Range is 20 to 250 CFM
STAGE 2 HP LOCK TEMP		Off, 40°F, 45°F, 50°F, 55°F	Heat Pump - for dual-fuel applications (locks out 2nd stage compressor)
COMPRESSOR PROTECT		On or Off	This feature prevents the compressor from being short cycled any time the compressor is turned "OFF".
DISPLAY PERFORMANCE REPORT		On or Off	
TERMINAL SETTINGS	D/H	Off	
		<b>Humidify</b>	
		Dehumidify	
	ACC	Off	
		Humidify	
		<b>Dehumidify</b>	
		Ventilation	
	O/B	<b>O (energized during cooling)</b>	
B (energized during heating)			
SYSTEM TEST MODE		Confirm Button	Installer run tests to check all output relays. Tests confirm signals between thermostat/unit are being sent/received. Stops system to run system tests
RESET SETTING		Confirm Button	Resets all parameters to factory settings
RESTART		Confirm Button	Reboot the thermostat.

## Advanced Settings Parameter Descriptions

Table 6. Parameter Descriptions

Parameter Name	Definition
Smooth Setback Recovery (SSR)	<p>SSR is an algorithm designed to smoothly reach a occupied program schedule setpoint. The algorithm looks 2 hours ahead for the occupied program schedule period's setpoint. If the occupied setpoint requires the system to turn on (present temperature below the heat setpoint or above the cool setpoint), then SSR will calculate a new setpoint. Once initiated, SSR monitors the change in room temperature and calculates a new setpoint every 30 seconds. Then SSR provides this new setpoint for the heating and cooling algorithms; the new setpoint will be displayed on the User Interface.</p> <p><b>SSR Rules:</b></p> <ul style="list-style-type: none"><li>• SSR is enabled when both Smooth Setback Recovery" is set to enabled (default) and the program schedule is turned on.</li><li>• SSR does NOT turn off stage delay timers.</li><li>• SSR will NOT change the dead band between heating and cooling modes.</li><li>• SSR will not overshoot the target set point.</li><li>• SSR will reset if the user updates the program schedule during the active SSR period. Smooth Setback Recovery - default is enabled .</li></ul> <p><b>NOTE:</b> <i>SSR aims to bring the sensor temperature (room temperature) to the value of the next active set point at the exact time the next active set point is associated with. This means that conditioning to reach the next active set point starts before the currently active set point period expires.</i></p>
Offset	<p>This is a feature that lets you adjust the room temperature reading +/- 5°F. This helps if your thermostat is in a slightly warm or cold spot, or if the room temperature does not match your old thermostat.</p> <p>The other option setting in our thermostat is humidity offset which is basically the same as temperature, but works on a humidity percentage instead.</p>

**Table 6. Parameter Descriptions**

Parameter Name	Definition
<b>Stage Differential</b>	<p>There are four options for stage differential:</p> <ul style="list-style-type: none"><li>• 1st Stage Differential: The default is 1.0°F. The first stage differential is the difference between the equipment activation and deactivation temperatures. The first stage differential is used in all models. It can be programmed between 0.5 and 8.0°F in 0.5°F steps.</li><li>• 2nd Stage Differential: The default is determined by the system setup. The second stage differential is used in the multi-stage model only. The second stage differential is the difference in temperature between the second stage activation and the first stage activation. It can be programmed between 0.5 and 8.0°F in 0.5°F steps. If system has only 1st stage equipment, this item is hidden from installer screen.</li><li>• 3rd Stage Differential: This setting is used with the multi-stage model, in heat pump applications only. The default is determined by the system setup. The third stage differential is the difference in temperature between the third stage activation and the second stage activation. It can be programmed between 0.5 and 8.0°F in 0.5°F steps. If system has no more than three stages equipment, this item is hidden from installer screen.</li><li>• 4th Stage Differential: This setting is used with the multi-stage model, in heat pump applications only. The default is determined by the system setup. The fourth stage differential is the difference in temperature between the fourth stage activation and the third stage activation. It can be programmed between 0.5 and 8.0°F in 0.5°F steps. If system does not have fourth stage equipment, this item is hidden from installer screen.</li></ul>

**Table 6. Parameter Descriptions**

Parameter Name	Definition
<b>Stage Delays</b>	<p>There are four settings for this option:</p> <ul style="list-style-type: none"><li>• <b>Stage Delay Timer:</b> The user shall be able to select ON (default) or OFF for stage delay timers. When OFF is selected all STG DELAYS timers (STG 2 DELAY, STG 3 DELAY, STG 4 DELAY) are disabled. This means that the stages are changed based on the temperature and not the timer delays. When ON is selected all STG DELAYS timers are enabled and set to their default values (20min). If system has only first stage equipment, this item is hidden from installer screen.</li><li>• <b>2nd Stage Delays:</b> The Stage Delay option is enabled when ON is selected from STG Delay Timers. The second stage delay is used in the multi-stage model only. The default is 20 minutes. If the first stage fails to advance the ambient temperature toward the setpoint by 1.0°F during each consecutive programmed time delay, then the second stage is activated until demand is satisfied. It can be programmed from 5 to 120 minutes in 5-minute steps. If system has only first stage equipment, this item is hidden from installer screen.</li><li>• <b>3rd Stage Delays:</b> The Stage Delay option is enabled when ON is selected from STG Delay Timers. This setting is used with the multi-stage model, in heat pump applications only. The default is 20 minutes. If the second stage fails to advance the ambient temperature toward the setpoint by 1.0°F during each consecutive programmed time delay, then the third stage is activated until demand is satisfied. It can be programmed from 5 to 120 minutes in 5-minute steps. If the system has no more than three stages, this item is hidden from the installer screen.</li><li>• <b>4th Stage Delays:</b> The Stage Delay option is enabled when ON is selected from STG Delay Timers. This setting is used with the multistage model, in heat pump applications only. The default is 20 minutes. If the third stage fails to advance the ambient temperature toward the set point by 1.0°F during each consecutive programmed time delay, then the fourth stage is activated until demand is satisfied. It can be programmed from 5 to 120 minutes in 5-minute increments. If the system does not have a fourth stage, this item is hidden from installer screen. If temperature is stuck at a value lower than the set point and multiple stages have been turned on because of the delay timers expired (not because of the temperature), all these stages shall stay on until the required temperature (set point + 0.5) is reached.</li></ul>
<b>H/C STGS Locked In</b>	<p>The user shall be able to select disable or enable for H/C STGS LOCKED IN mode. In disable, mode different stages of heat or cool are turned off separately. In enable mode, different stages of heat or cool are turned off together.</p>



**Table 6. Parameter Descriptions**

Parameter Name	Definition
<b>Stage 2 HP Lock Temp</b>	The User shall be able to select the STG 2 HP lock temp from 40F, 45F, 50F, 55F or OFF. The value is used in dual fuel algorithm to lock the second stage of compressor .The default is OFF which means it is disabled and is not used in dual fuel algorithm. If system has only 1st stage equipment, this item is hidden from installer screen.
<b>Feels Like</b>	This feature will display the home temperature based on a combination of inputs. Feels Like uses outdoor temperature, indoor temperature, and indoor humidity to determine the "feels like" condition of the home.
<b>Wider Set Point Range</b>	By default your thermostat operates within a range of 60-90°F. Enabling this options changes the range to 44-99°F.
<b>Heating Mode: Normal or Comfort</b>	<p>Options are Normal and Comfort. Default is Normal. When changing to Comfort Mode, several parameters are automatically modified for optimal system operations. The changed parameters are listed on the screen when set to Comfort.</p> <ul style="list-style-type: none"> <li>• Normal - This setting cools the home to the desired temperature setting. Once second-stage is activated by timer or differential, it will not stage down to first-stage until the next heating cycle demand.</li> <li>• Comfort - This is when the system could automatically stage up or down based on the current load demand.</li> </ul>
<b>Smart Away</b>	This setting when enabled controls the temperature in the home when no one is home. For this to function, the Lennox Home app needs to be installed on a mobile device.
<b>Low Balance Point</b>	(Multistage Heat Pump Model only) -The default is 25°F. This option will only be available if an outdoor sensor is installed. If the outside temperature is below the programmed Low Balance Point, then the compressor stage operation is disallowed. This protects the compressor from operation and damage in cold outdoor temperatures. Also, if the heat pump is not effective at a low outdoor temperature, then it is more comfortable and efficient to go directly to the second stage. Low Balance Point can be disable in this screen. When this is enable, the options are from -40°F to (the High Balance Point temperature -2) in 1.0°F steps.
<b>High Balance Point</b>	The default is 50°F. This option is only available if an outdoor sensor is installed. If the outside temperature is above the High Balance point, then the auxiliary heat stage is disallowed. This prevents the more expensive auxiliary heat stage from operating, and forces the more efficient heat pump to satisfy the demand. High Balance Point can be disable in this screen. When this is enable, the high balance point range is from (the low balance point + 2) up to 75°F.
<b>Deadband</b>	The deadband setting is the minimum difference between the cooling and heating setpoints. This setting is used in auto-changeover to ensure smooth equipment operation. It also allows for flexibility of Humiditrol operation. The default deadband is 3 and the deadband is adjustable from 3 to 9°F degrees.

**Table 6. Parameter Descriptions**

Parameter Name	Definition
Offset	<p>There are two options for offset which are:</p> <ul style="list-style-type: none"> <li>• Temperature offset can be used to offset the displayed space temperature by up to +/- 5 degrees. The default temperature offset is zero. This offset also applies to the control temperature.</li> <li>• Humidity offset can be used to offset the displayed room humidity by up to +/- 10%, the default offset is 0.</li> </ul>

**Stage Control**

The following figures list typical configurations.

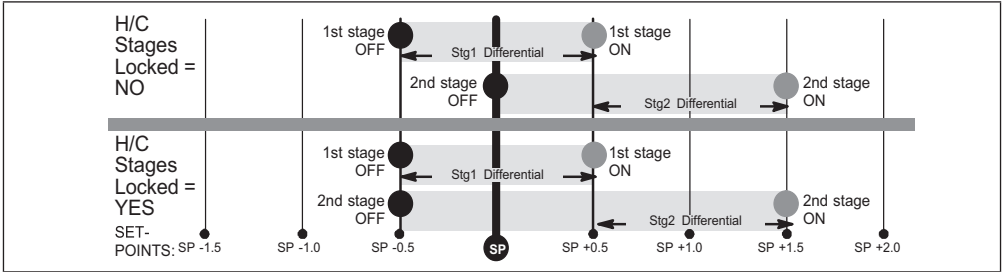

**Figure 2. Cooling - 1 or 2 stages**

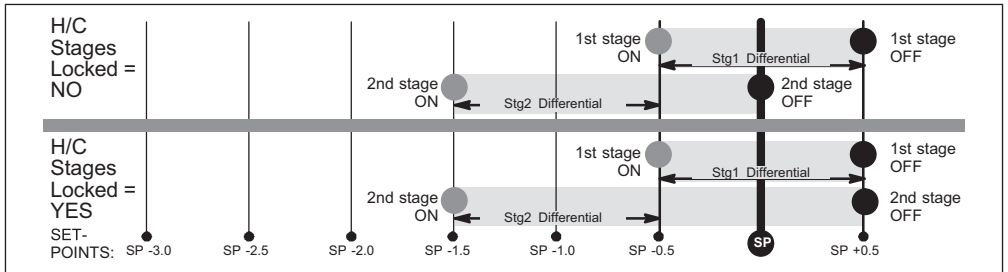

Figure 3. Heating - Non-Heat Pump or Heat Pump w/o backup heat - 1 or 2 stages

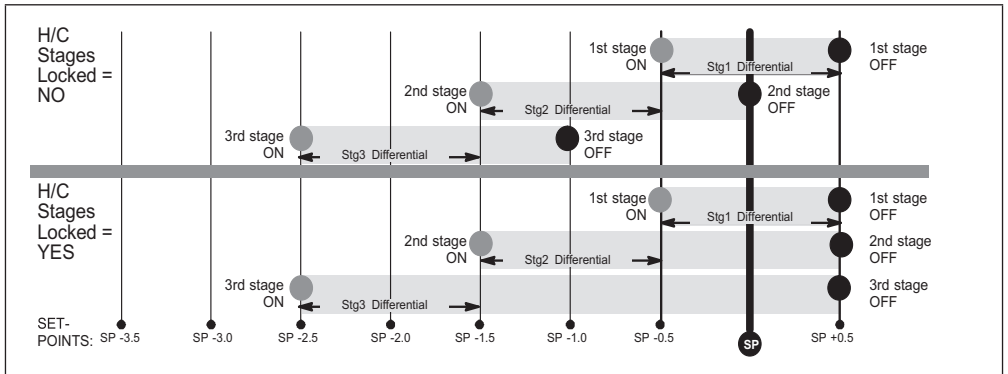

Figure 4. Heating - Heat Pump w/electric - 3 stage (2 compressor / 1 backup OR 1 compressor / 2 backup)

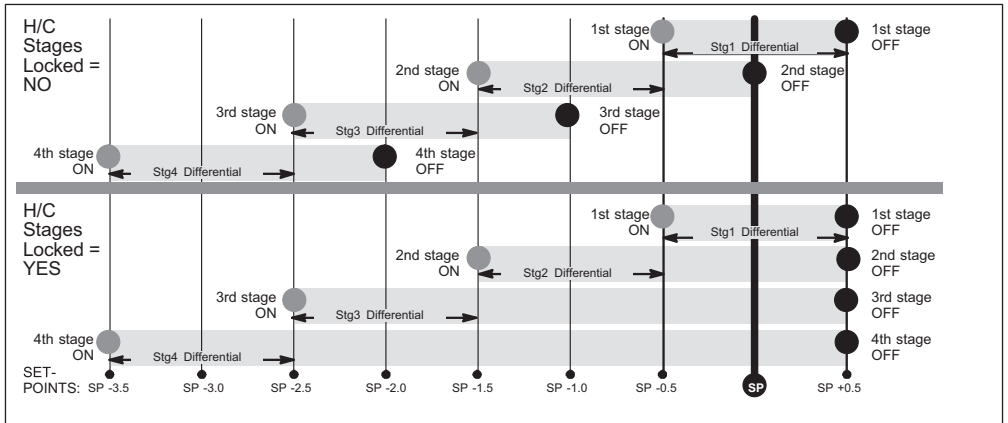

Figure 5. Heating - Heat Pump w/electric - 4 stage (2 compressor / 2 backup)

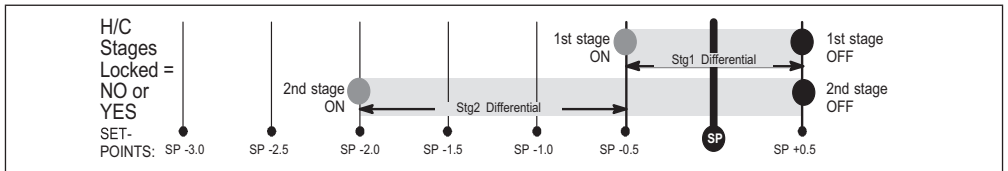

Figure 6. Heating - dual fuel - 2 stage (1 compressor / 1 backup)

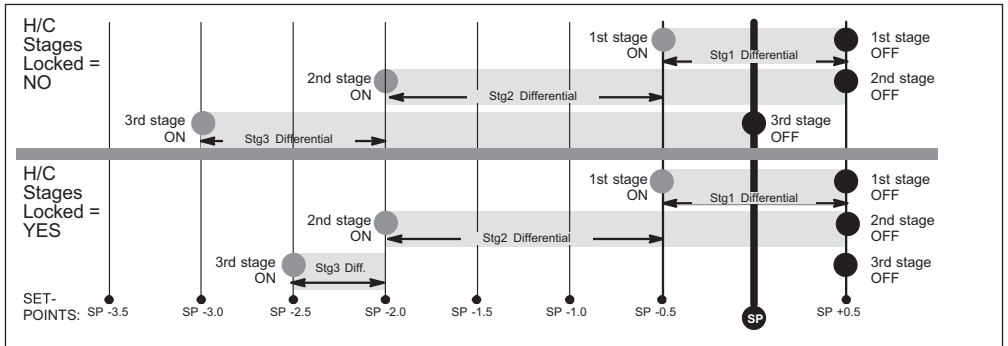

Figure 7. Heating - dual fuel - 3 stage (1 compressor / 2 backup)

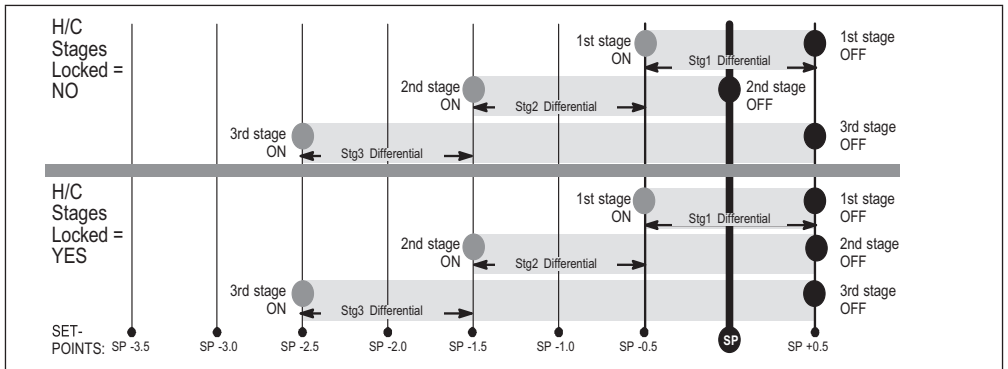

Figure 8. Heating - dual fuel - 3 stage (2 compressor / 1 backup)

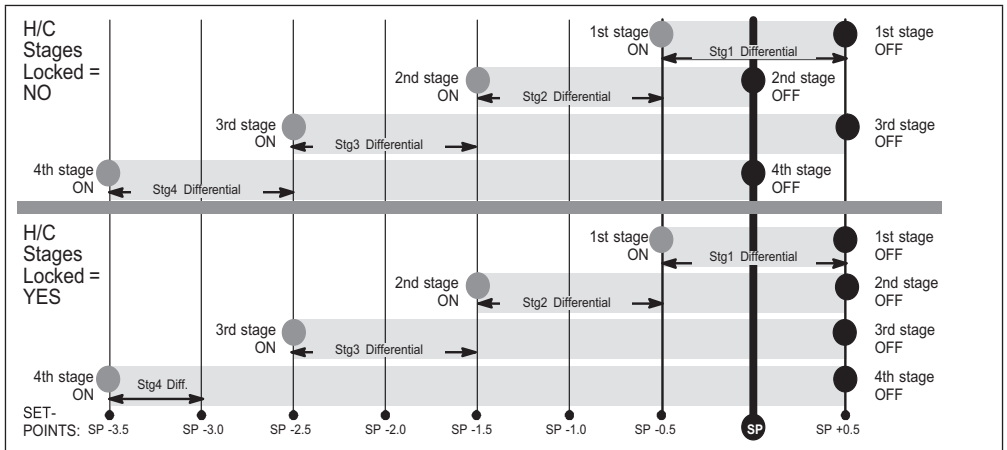

Figure 9. Heating - dual fuel - 4 stage (2 compressor / 2 backup)

### Wi-Fi Connection

Wireless networks supported by this system are:

- 802.11b is 2.4Ghz band (max 11 Mbit/s)
- 802.11g is 2.4Ghz band (max 54 Mbit/s)
- 802.11n is 2.4Ghz band (max 130 Mbit/s)

This is for connecting the thermostat to a secure home wireless network.

**NOTE:** A router with Bonjour capabilities is required for this function. Check the router functions if the thermostat does not connect. Apple Bonjour® is an implementation of zero-

configuration networking (Zeroconf), a group of technologies that includes service discovery, address assignment, and host name resolution.

**NOTE:** Never use a home guest account and never use an open router connection (non-secure).

**NOTE:** Always use a secure connection physically located in the home where the thermostat is located.

**NOTE:** If thermostat will not connect to the home router, then try using a hot spot to check thermostat Wi-Fi connectivity. A Wi-Fi extender may be required or move the router closer to thermostat for connection.

1. Touch the Menu icon in the upper right-hand corner of the display.

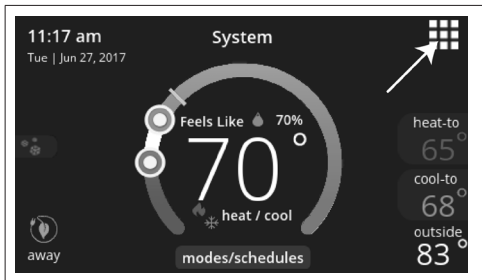

2. Touch the settings option on the menu.

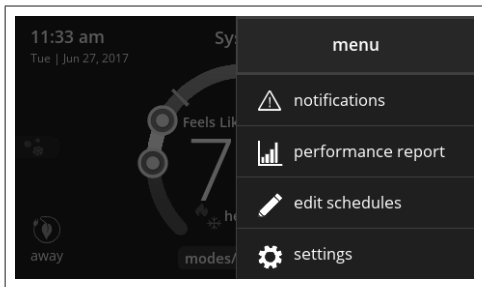

3. If Wi-Fi is set to disabled, touch the > icon to enable. The Wi-Fi screen will appear where you can toggle it to ON.

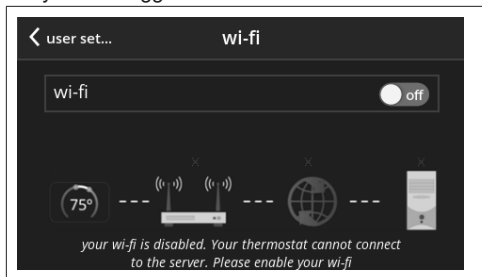

### Connecting to Visible Home Wi-Fi Access Point

1. Touch Wi-Fi network. This will display a list of visible Wi-Fi networks within range of the thermostat.
2. Select the homeowner network and type in the password. Touch **join** to continue.

**NOTE:** The thermostat can connect to a home wireless router that uses up to 32 characters in the access point name (visible or hidden).

**NOTE:** If you wish to see the characters you are typing, check show password. The thermostat will support up to a 63 character password. The password cannot contain the % or # symbols.

- If joining the network was successful, the access point name will appear next to Wi-Fi networks.

### Connecting to Hidden Home Wi-Fi Access Point

---

- Touch Wi-Fi network. Scroll down to others.
- Enter new network information. You will need the name of the access point and the type of security being used. Select Security. Options are: none, WEP, WPA and WPA2. If your home Wi-Fi connection is unsecured, then Wi-Fi security must be enabled using WEP, WPA or WPA2 via the router before proceeding. Consult your router documentation on how to enable Wi-Fi security.
- Enter the password.
- Touch join to complete.
- If joining the hidden network was successful, the access point name will appear next to wi-fi networks.

Whether connecting to a visible or hidden network, if successful, a check mark will appear above both the router and Internet icons.

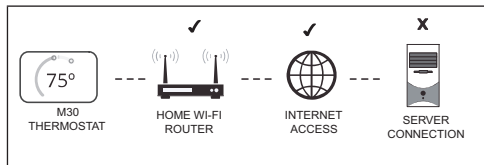

### Wireless Terminology

---

The following terminology is used:

- Received Signal Strength Indication (RSSI). This indicates the signal strength of the Wi-Fi router being received by the scanning device (i.e., smart phone). So the higher the RSSI number (or less negative in some devices), the stronger the signal.
- Internet Protocol Address (IP address). This is an address assigned by your home router for each network device (e.g., computer, printer, thermostat).

### Wireless Connectivity Troubleshooting Tips

---

Locate the thermostat and router away from other devices that could possibly interfere with wireless communications. Some examples of other devices that could interfere are:

- Microwave ovens
- Wireless cameras
- Portable phones and bases
- Baby monitors
- Wireless speakers
- Bluetooth devices
- Garage door openers
- Neighbor's wireless devices



To eliminate a possible source of interference, temporarily disable any nearby 2.4Ghz band devices in the home and see if Wi-Fi performance has improved.

## **Determining Wireless Connection Signal Strength**

The ideal signal strength range for the thermostat is -1 to -69 Received Signal Strength Indication (RSSI). The signal strength can be viewed from the thermostat interface.

1. Press **NETWORK SETTINGS**; This screen shows a graphical view of buttons representing OPEN and SECURE wireless networks, along with button for adding a network.
2. Select the access point that has already been established and connected.
3. When selecting the info icon, a screen will appear which will display an option to forget the network and IP address assigned to the thermostat by your router, sub-net mask, router, DNS and RSSI.
4. If the RSSI signal strength is anywhere between -9 to -69, then the signal strength is sufficient. If outside this range, then either relocate the router closer to the thermostat, add a repeater, or move the thermostat. Adjusting antenna on router may resolve the issue.

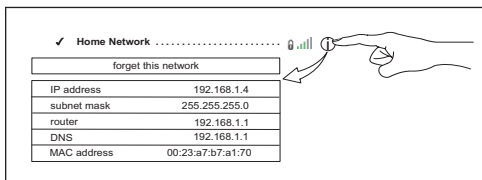

## Alert Codes

The following is a priority condition descriptions:

### Service Urgent

---

- No Heat / No Cool.
- No ventilation or could cause equipment or property damage.
- Requires a service call within 24 hours.

### Service Soon

---

- Not meeting set point / Homeowner perception of comfort not being met.
- Have partial heat/cool operation.
- Requires a service call within 24-48 hours.

### Service Soon / Service Urgent

---

Codes that can escalate to a higher level after a set parameter of cycles or time.

### Maintenance

---

Items the Dealer sets / plans intervals for (replace filter, uv bulbs) or will require 'tune-up/cleaning' a piece of equipment.

### Dealer Information only

---

- System is operating within normal parameters.
- Data accessible to Dealer for example would be system history.

**Table 1. Alert Codes and Troubleshooting**

Alert Code	Priority Condition	Actual Displayed Alert Text Under dealer control center > Notifications	Component or System Operational State and Troubleshooting Tip	How to clear alert code
29	Service Urgent	Over Temperature Protection	<p>The thermostat is reading an indoor temperature that is higher than 90°F (factory default). The thermostat will not allow any heating operation to begin until it senses an indoor temperature lower than 90°F. Indoor temperature rose above 90°F during a heating or cooling demand.</p> <ul style="list-style-type: none"> <li>• Heating operation is not allowed.</li> <li>• Check to ensure that heating equipment is not stuck ON (reversing valve, etc.)</li> <li>• Check the accuracy of the thermostat temperature sensor.</li> <li>• Select cooling system mode to cool the indoor space below 90°F.</li> </ul>	Automatically clears when the system detects that the issue no longer exists.
30	Service Soon / Service Urgent	Low Temperature Protection	<p>The thermostat will not allow any cooling operation to begin until it senses a temperature higher than 40°F.</p> <ul style="list-style-type: none"> <li>• Cooling operation is not allowed.</li> <li>• Check to ensure that cooling equipment is not stuck ON.</li> <li>• Check accuracy of the thermostat temperature sensor.</li> <li>• Select heating system mode to heat the indoor space to above 40°F.</li> </ul>	Automatically clears when the system detects that the issue no longer exists.

**Table 1. Alert Codes and Troubleshooting**

Alert Code	Priority Condition	Actual Displayed Alert Text Under dealer control center > Notifications	Component or System Operational State and Troubleshooting Tip	How to clear alert code
180	Service Soon	Outdoor Temperature Sensor Problem	<p>The thermostat has found a problem with the outdoor sensor in the outdoor unit or the optional outdoor sensor connected to the indoor unit. In normal operation after system component control recognizes sensors, the alert code will be sent if valid temperature reading is lost.</p> <ul style="list-style-type: none"> <li>• Compare outdoor sensor resistance to temperature / resistance charts in unit installation instructions.</li> <li>• Replace sensor pack or stand alone outdoor sensor.</li> <li>• At the beginning of (any) configuration, furnace, air-handler control or equipment interface module will detect the presence of the sensor(s).</li> <li>• If detected (reading in range), appropriate feature will be set as 'installed' and shown in the 'About' screen.</li> </ul>	Automatically clears upon configuration, or sensing normal values.

**Table 1. Alert Codes and Troubleshooting**

Alert Code	Priority Condition	Actual Displayed Alert Text Under dealer control center > Notifications	Component or System Operational State and Troubleshooting Tip	How to clear alert code
610	Service Urgent	Low Room Temperature Detected	<p>This alert will automatically notified the user that a low room temperature condition exist. A notification is displayed on the HD display and email notification sent to homeowner and dealer.</p> <p>The freeze alert protection parameter range is 30°F to 50°F (-1.11 to 10.0°C). Default is 40°F (4.44°C).</p> <p><b>NOTE:</b> <i>Notification is dependent on the thermostat having a active Wi-Fi connection and the user account has been setup and includes a valid email address.</i></p>	Automatically clears when condition is resolved.
611	Service Urgent	High Room Temperature Detected	<p>This alert will automatically notified the user that a high room temperature condition exist. A notification is displayed on the HD display and email notification sent to homeowner and dealer.</p> <p>The heat alert protection parameter range is 80°F to 100°F (26.67 to 37.78°C). Default is 90°F (32.22°C).</p> <p><b>NOTE:</b> <i>Notification is dependent on the thermostat having a active Wi-Fi connection and the user account has been setup and includes a valid email address.</i></p>	Automatically clears when condition is resolved.

**Table 1. Alert Codes and Troubleshooting**

Alert Code	Priority Condition	Actual Displayed Alert Text Under dealer control center > Notifications	Component or System Operational State and Troubleshooting Tip	How to clear alert code
700	Service Urgent	Thermostat Temp Sensor Problem	<p>The HD display's internal temperature sensor is not operating correctly. To resolve this issue, try the following:</p> <ul style="list-style-type: none"> <li>• Remove HD display from mag-mount and reattaching.</li> <li>• Seal hole in wall behind mag-mount to minimize exposure to unconditioned air from inside the wall.</li> <li>• Run "<b>reset all</b>" under dealer control center.</li> <li>• If issue persist, then replace the HD display.</li> </ul>	Automatically clears when the system detects that the issue no longer exists.
703	Service Soon	Thermostat Humid Sensor Problem	Thermostat Humid Sensor Problem. Sensor is damaged or data is corrupted possibly..	First try a system reset, then if persists the thermostat would need replacement.
3000	Maintenance	Replace Filter 1	Not Applicable	Reset filter reminder for both
3001	Maintenance	Replace Filter 2	Not Applicable	

**Table 1. Alert Codes and Troubleshooting**

<b>Alert Code</b>	<b>Priority Condition</b>	<b>Actual Displayed Alert Text Under dealer control center &gt; Notifications</b>	<b>Component or System Operational State and Troubleshooting Tip</b>	<b>How to clear alert code</b>
3002	Maintenance	Replace Humidifier Pad	Not Applicable	Reset Humidifier pad reminder
3003	Maintenance	Replace UV Bulb	Not Applicable	Reset UV Light reminder
3004	Maintenance	Maintenance Reminder	Not Applicable	Make service appointment with dealer and reset reminder
3005	Maintenance	Pure Air Maintenance	Not Applicable	Make service appointment for Pure Air maintenance with dealer and reset reminder

## System Test Modes

After the thermostat has been installed and set-up, the installer may run a system test function (accessed through the installer settings menu), to test all cooling, heating, emergency heating stages and FAN outputs.

Select system test mode. A pop-up will be displayed indicating all equipment will be stopped. Touch confirm to continue.

Pressing the OFF button next to the desired option will change the status to ON and will enable the relay for that terminal. Pressing again will turn OFF the relay. Touch the left arrow (<) to exit the system test mode.

## IMPORTANT

The thermostat System Test Mode provides the technician the ability to test the thermostat relay outputs and can be used to assist in the testing and troubleshooting of the equipment. Important information related to thermostat System Test Mode are outlined in "Table 7. Thermostat Test Modes".

Table 7. Thermostat Test Modes

Test	Description
Blower	Test will provide a relay output on "G" and the equipment will operate on the equipment continuous fan speed. Equipment continuous fan speed may not be full cooling air volume.
Cooling - 1st Stage	Test will provide a relay output on "Y1" for the compressor, "G" for the blower and "O" Reversing Valves (heat pump units). If the dehumidification mode option was selected during thermostat setup, the thermostat will not provide a 24Vac Output on "D" during the system test mode and the equipment will operate at the dehumidification air volume. The dehumidification air volume is typically 70% of the cooling air volume. If testing requires 100% of the cooling air volume, a jumper will need to be installed between "R" and "DS" at in the indoor equipment.
Cooling - 2nd Stage	Test will provide a relay output on "Y1" for first stage compressor "Y2" for second stage compressor, "G" for the blower and "O" Reversing Valves (heat pump units). If the dehumidification mode option was selected during thermostat setup, the thermostat will not provide a 24Vac Output on "D" during the system test mode and the equipment will operate at the dehumidification air volume. The dehumidification air volume is typically 70% of the cooling air volume. If testing requires 100% of the cooling air volume, a jumper will need to be installed between "R" and "DS" at in the indoor equipment.



## Save Energy Default

Energy saving recommended set points for heating and cooling can help save energy. The time and temperatures reference in the following table are pre-programmed into the thermostat to achieve energy savings.

Scroll to **ENERGY SAVING DEFAULT**; touch to select. Read the message on the screen and to continue, touch **CONFIRM**.

**Table 8. Energy Saving Set Points**

Time	Heating	Cooling
Wake	70°F (21°C)	78°F (25°C)
Leave	62°F (17°C)	85°F (29°C)
Return	70°F (21°C)	78°F (25°C)
Sleep	62°F (17°C)	82°F (28°C)

**NOTE:** Humidification and dehumidification are not part of the energy savings program. A higher utility bill may occur when not using the setpoints in this table.

## Dehumidification Control

### Normal and Max

Dehumidification options are listed at **menu > settings > humidity**. Under **Humidity Control**, select **dehumidify** to enable dehumidification. By default it is **disabled**.

There are four setting options which are Normal, Max, Humiditrol\* and Aux Dehumidifier (requires hardware accessory installed). Slide bar adjust with a range of 40% to 60% RH.

**Table 9. Dehumidification Modes**

Option	Description
Normal	<ul style="list-style-type: none"><li>• Activate: If RH measured is <math>\geq</math> (RH set point + 2%), and, Cool is ON, then D is inactive (open circuit), and G is ON (if not already ON), and Y2 (if available) is ON.</li><li>• Deactivate: If RH measured is <math>\leq</math> (RH set point - 2%) or Cool is OFF, then D is active (24VAC present). G returns to the state determined by the thermostat control, either ON, Auto, or CIRC. (OR) If there is no more cool demand, then D is active (24VAC present). G returns to the state determined by the thermostat control, either ON, Auto, or CIRC, and Y2 (if available) is OFF.</li></ul> <p><b>NOTE:</b> Note that H is inactive (open circuit) during dehumidification.</p>

**Table 9. Dehumidification Modes**

Option	Description
Max	<ul style="list-style-type: none"> <li>Activate: IF RH measured is <math>\geq</math> (RH set point + 2%), and if T measured <math>\geq</math> T set point - 0°F to 4°F )AND unit is in Cool mode (O = ON), then D is inactive (open circuit), and G, Y1, and Y2 (if available) are ON.</li> <li>Deactivate: IF RH measured is <math>\leq</math> (RH set point - 2%), or if T measured &lt; T set point - 0°F to 4°F) or unit isn't in Cool mode(B = ON), then D is active. Y1 and Y2 are OFF and G returns to the state determined by the thermostat control, either ON, Auto, or CIRC.</li> </ul> <p><b>NOTE:</b> H is inactive (open circuit) during dehumidification.</p>

### Humiditrol

This option is available if the Humiditrol accessory is present and enabled in the Advanced Settings > System Setup. Under **Advanced Settings > Terminal Settings**, verify that the D/H or ACC terminals are configured correctly for dehumidify control. In this mode, the D/H terminal (if selected for dehumidify) is always ON (24VAC) when the outdoor temperature is greater than 95°F. This prevents the system blower from running at reduced speed if the outdoor temperature is greater than 95°F.

**NOTE:** The outdoor temperature sensor **MUST** be attached to the unit in order to use this mode.

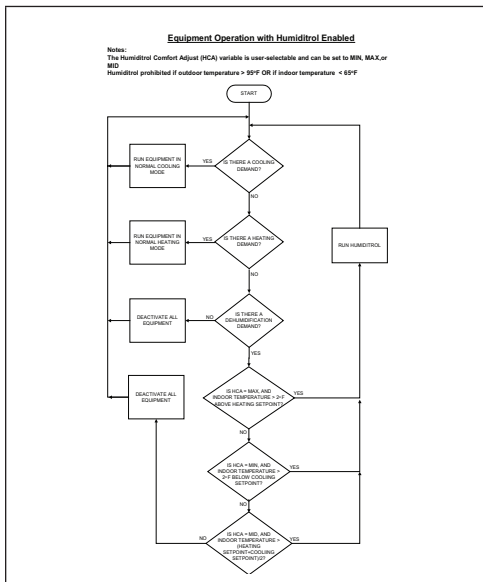

**Figure 10. Equipment Operation with Humiditrol Enabled**

### Auxiliary Dehumidifier

This option is available if the Auxiliary Dehumidifier accessory is present and enabled in the **Advanced Settings > System Setup**. Under **Advanced Settings > Terminal Settings**, verify that the

D/H or ACC terminals are configured correctly for dehumidify control.

**Cooling demand only:** Y1 and Y2 come on initiating the conventional cooling only demand.

**Dehumidification demand only:** D is de-energized (G should also be energized) but with out Y1 or Y2. D remains off until the demand is satisfied or if a true cooling demand comes on (unit must be in cooling mode).

**Both cooling and dehumidification demands:** Y1 and Y2 are ON (G must be ON and D is also 0 volts) When cooling is satisfied , D is still 0 volts and G must stay ON until dehumidification demand is satisfied.

**Table 10. Auxiliary Dehumidifier Option**

Option	Description
Normal	<ul style="list-style-type: none"> <li>• Activate: If RH measured is <math>\geq</math> (RH set point + Activate: IF RH measured is <math>\geq</math> (RH set point + 2%), and AND unit is in Cool mode (O = ON), THEN D is inactive (open circuit), AND G is ON.</li> <li>• Deactivate: IF RH measured is <math>\leq</math> (RH set point - 2%), or unit isn't in Cool mode(B = ON), THEN D is active. G returns to the state determined by the thermostat control, either ON, Auto, or CIRC.</li> </ul>

### Humidification Control

This option is available if the humidifier accessory is present and enabled in the **Advanced Settings > System Setup**.

Under **Advanced Settings > Terminal Settings**, verify that the D/H or ACC terminals are configured correctly for humidification control.

Humidification is provided only when both a humidification accessory is installed and the thermostat is in heat mode.

- Setpoint Range: 15 – 45% RH
- Relative Humidity Controlled to 2% of Setpoint (1% resolution)
- “D/H” Terminal to Humidifier (deactivated during cooling)
- This behavior changes based on D/H terminal or ACC terminal

### Normal and Max

The following table describes the function of normal and max humidification settings.

**Table 11. Humidification Modes**

Option	Description
Normal	<p>(Humidification only with Heat Demand)</p> <ul style="list-style-type: none"> <li>• Activate: If RH measured is <math>\leq</math> (RH setpoint - 2%), and, heat is ON, then H is ON, and G is ON (if not already ON).</li> </ul> <p><b>NOTE:</b> <i>In Normal humidification mode, thermostat should not activate G when used with Gas/Oil systems</i></p> <ul style="list-style-type: none"> <li>• Deactivate: If RH measured is <math>\geq</math> (RH set point + 2%) or Heat is OFF then H is Off. G returns to the state determined by the thermostat control, either ON, Auto, or CIRC. (OR) If there is no more heat demand, then H is Off. G returns to the state determined by the thermostat control, either ON, Auto, or CIRC.</li> </ul> <p><b>NOTE:</b> <i>The D terminal is active during humidification.</i></p>
Max	<p>(Humidification with or without Heat Demand)</p> <ul style="list-style-type: none"> <li>• Activate: IF RH measured is <math>\leq</math> (RH set point - 2%), and unit is in heat mode (regardless of whether a heating demand exists), then H is ON, and G is ON (if not already ON).</li> <li>• Deactivate: IF RH measured is <math>\geq</math> (RH set point + 2%) or unit is not in Heat mode (O = ON), then H is Off. G returns to the state determined by the thermostat control, either ON, Auto, or CIRC.</li> </ul> <p><b>NOTE:</b> <i>The D terminal is active during humidification. Following is the table that shows status of FAN for different humidity modes and system outputs.</i></p>

## Normal and Max Dew Point Control

To set the system to Normal Dew Point Control, select normal and dew point options under settings humidity option.

To set the system for Max Dew Point Control, select **Max and Dew Point Control**.

**NOTE:** *Outdoor air temperature sensor is required for this feature.*

**Table 12. Dew Point Control Modes**

Option	Description
Normal	<p>Normal Dew Point Control mode is useful in colder climates where moisture can collect on interior window surfaces. Normal dew point control helps to minimize this condensation. In this mode the activation and deactivation of D/H terminal is controlled as follows.</p> <p>RH set point= <math>-5^{\circ}\text{Outdoor Temp} + 25 + \text{RH user dew point adjustment}</math></p> <p>where:</p> <p>RH user dew point adjustment is user-selectable and cannot exceed +/-15%, default RH user dew point adjustment = 0</p> <p>The RH set point cannot exceed 45%</p> <p>The minimum RH set point is 15%</p>

**Table 12. Dew Point Control Modes**

Option	Description
Max	<p>Max Dew Point Control mode is also useful in colder climates where moisture can collect on interior window surfaces. Max Dew point control helps to minimize this condensation. In this mode the activation and deactivation of H terminal is controlled as it is done in the Max.</p> <p>RH set point= .5*Outdoor Temp + 25 + RH user dew point adjustment where: RH user dew point adjustment is user-selectable and cannot exceed +/-15%, default RH user dew point adjustment = 0 The RH set point cannot exceed 45%</p>

### Ventilation Control

This equipment is designed to provide fresh air while exhausting an equal amount of stale air.

### Ventilation Rates

The S30 ventilation function is only a turn on - turn off feature. All CFMs must be adjusted from the HRV/ERV unit. The ventilation function can be controlled by outdoor temperatures and by timers in the thermostat. The ventilation feature can also control 1 and 2 stages of ventilation operation.

Thermostat ventilation CFM parameters are to be adjusted only after the HRV/ERV set up is completed and the CFMs are known. Once the thermostat's CFMs are adjusted they are used with

the thermostat's timer algorithm to determine how long to run the HRV/ERV.

### Energy Recovery Ventilator (ERV)

The ERV unit is equipped with an enthalpic core. This device is designed for use in warm, humid climates with heavy air conditioning loads. The ERV unit transfers both sensible (temperature) and latent (moisture) heat from incoming fresh air to the stale air as it is being exhausted; thus, reducing the air conditioning load.

### Heat Recovery Ventilator (HRV)

The HRV unit is equipped with an aluminum core. The device uses the stale air that is being exhausted to condition the fresh air as it is being brought in.

Parameter settings and descriptions are listed in "Table 5. Advanced Settings" on page 14. The table below list which parameters are available for the Fresh Air Damper, ERV and HRV equipment.

### Fresh Air Damper

This option is used to control a damper connecting outside air to the return plenum of the system. When a fresh air damper style of ventilation is added to the system, and ventilation is required, the ventilation demand is serviced by energizing one relay to close or open the relay contacts connected to the fresh air damper and commanding the blower to run at a rate of at least the continuous fan speed.

### Operation of Fresh Air Dampers with Environmental Overrides

- When the Non-ASHRAE Compliant mode is selected (Timed), the system first checks for the outdoor temperature and dew point to be within the set parameter range before allowing ventilation to occur.
- When the ventilation changes states (on/off) due to an environmental override, it will remain in that state for a minimum of 10 minutes before again changing states due to an environmental override.
- Operation is otherwise the same as the ASHRAE compliant method.
- Terminals ACC1 and ACC2 are dry contacts in this mode.

### Ventilation Wiring

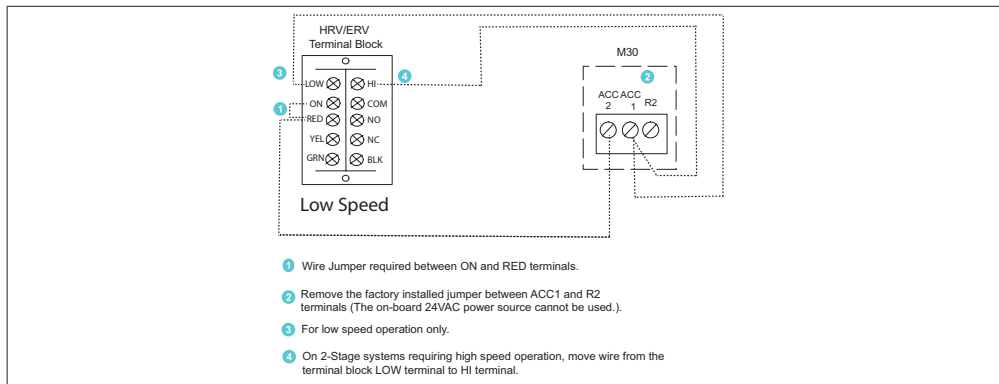

Figure 11. ERV / HRV Wiring

See “Table 1. Terminal Designations” on page 7 for further details on each terminal.

## Ventilation Control Modes

Parameter settings and descriptions are listed in “Table 5. Advanced Settings” on page 14. The table below list which parameters are available for the Fresh Air Damper, ERV and HRV equipment.

### Installer Checklist

Table 13. Installation Checklist

Item	Description	Yes	No
1	Is the thermostat properly mounted to either a wall stud or wall? (Do not mount on exterior wall or near any ventilation outputs, doorways or location that could be directly exposed to sunlight)		
2	Are all terminals wiring properly connected and tight?		
3	When required, is the outdoor air temperature sensor (OATS) properly connected and isolated when used? Is the input enabled using the user interface? Go to <b>advanced settings &gt; outdoor sensor</b> and set to <b>YES</b> if not done so already. Then go to <b>settings &gt; display</b> and make sure the outdoor temperature display setting is configured for sensor. If OATS is not used, leave the setting on Internet.		
4	Have all the Thermostat Features been explained to the Home Owner?		
5	Has User manual been given to Home Owner?		
6	Has additional Alexa information not in user manual been given to Home Owner and shown where to find answers to additional questions? Go to <a href="http://www.myicomfort.com">www.myicomfort.com</a> Support page & FAQ.		
7	Is the Wi-Fi connected?		
8	Can the homeowner access the consumer portal ( <a href="http://www.myicomfort.com">www.myicomfort.com</a> ) from either a PC or tablet?		

**Table 13. Installation Checklist**

Item	Description	Yes	No
9	Has the homeowner downloaded the Lennox Home application from either Google Play or IOS App Store to their mobile devices?		
10	Is the Lennox Dealer account number or your main shop phone number been added to the dealer information screen? This will tie the homeowners system to your LennoxPROS account.		
11	If applicable, has the air handler's electric heat strips been commissioned? If not, commissioning of heat strips must be performed.		
12	Has a complete system test been run? If not, from the HD Display home screen go to <b>settings &gt; advanced settings &gt; view dealer control center &gt;</b> and select <b>tests</b> .		









## Index

### A

Advanced Settings 14  
Alert Codes 34  
Alert Codes and  
Troubleshooting 35

### B

Backplate 11  
Balance Points 16

### C

Commissioning 11  
Common Practices 6  
Compressor Protection 21  
Compressor Short Cycle 3

### D

Deadband 25  
Deadband Adjustment 17  
Dehumidification Control  
41  
    *Auxiliary Dehumidifier* 42  
    *Humidifrol* 42  
    *Normal and Max* 41  
Dimensions 3  
Display Performance  
Report 21

### E

Energy Recovery Ventilator  
(ERV) 45  
Energy Saving Defaults 41

### F

Feels Like 25

### H

H/C Stage Locked In 24  
Heat / Cool Stages Locked  
In 18  
Heating Mode 25  
Heat Recovery Ventilator  
(HRV) 45  
High Balance Point 25  
Humidification Control  
43, 45  
    *Normal and Max* 42  
    *Normal and Max Dew Point  
Control* 44

### I

Installer Checklist 47

### L

Low Balance Point 25

### N

New Installation 5

### O

Offset 22, 26  
Outdoor Air Temperature  
Sensor (OATS) 4  
Outdoor Sensor 16

### P

Parameter Descriptions 22

### R

Received Signal Strength  
Indication (RSSI) 33  
Replacement Installation 6  
Reset Settings 21  
Residual Cooling 16  
Restart Thermostat 21

### S

Smart Away 25  
Smooth Setback Recovery  
18, 22  
Stage 2 Heat Pump Lock  
Temp 21  
Stage 2HP Lock Temp 25  
Stage Control 26  
Stage Delays 18, 24  
Stage Differential 18, 23  
System Configurations 8  
System Setup 14, 15  
    *Dehumidifier* 16  
    *Humidifier* 16

*Indoor Unit Type* 15  
*Outdoor Unit Type* 15  
*Ventilator Settings* 14

System Test Mode 21, 40

### T

Temperature Control  
Mode 17  
Temperature Offset 18  
Terminal Descriptions 7  
Terminal Settings 21

### V

Ventilation 19, 20  
Ventilation Wiring 46

### W

Wall Insulation 17  
Wider Set Point Range 25  
Wi-Fi Connection 30  
    *Hidden* 32  
    *Visible* 31  
Wi-Fi Signal Strength 33  
Wi-Fi Troubleshooting 32  
Wireless Terminology 32  
Wiring Diagrams 8